

DIAMOND

Fiber Optic Components

PS

(Power Solution)

E-2000™ PS, F-3000™ PS, DMI PS
SINGLE MODE PC/APC 4°

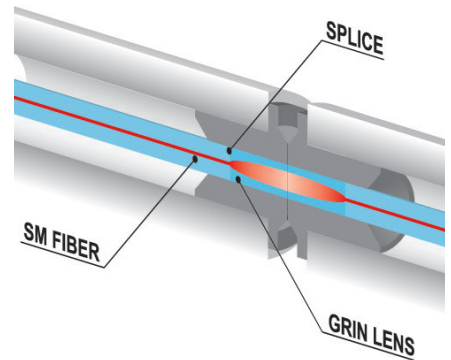
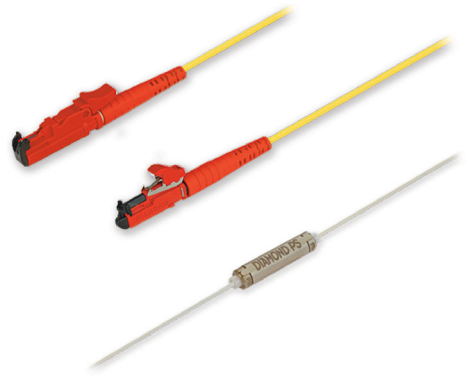

CABLE ASSEMBLIES AND ADAPTERS

Diamond PS connector systems are designed for high power applications up to 3 Watts optical power for SM fibers (6W for E-2000™ PS). These have been developed to support the continuous rise of higher bitrates and longer transmission distances within DWDM technology. Diamond PS connectors are based on contacted expanded beam technology; where a section of graded index fiber is spliced as a collimating lens, which enlarges the beam diameter and reduces power density at the connector interface. Using Diamond Active Core Alignment (ACA) technology, we can achieve unrivaled low IL performance for the PS technology by aligning the fiber exit angle instead of the core eccentricity as Diamond usually does on SM fiber. This technology is applicable to most connectors interfaces, but due to safety issues Diamond suggests to use it on E-2000™ and F-3000™ connectors with integrated metal protection caps and shutters.

All of the features, users have come to expect from the E-2000™, F-3000™ and DMI family, are available on the PS version.

For more information about the technical specifications, please refer to the PS Optical Interfaces datasheet available on Diamond website.

FEATURES AND BENEFITS

- ▶ 16x reduced power density
- ▶ Low Insertion loss
- ▶ Ultra high polish for High return loss
- ▶ E-2000™ and F-3000™ with integrated metal protection caps and Shutters
- ▶ E-2000™ with interchangeable colour- and mechanical-coded frames and thumb-latches.
- ▶ DMI: Minimal space requirement, PC board mount capability and excellent vibration resistance

STANDARDS

- ▶ Passed long term test at 6W, 2000h on E-2000™ PS connector
- ▶ Passed Performance qualification according to IEC 61753-2-1, cat. U
- ▶ Passed Reliability qualification according to IEC 62005-9-2, cat. U
- ▶ Passed Long term Damp Heat according to Telcordia GR-032685°C / 85% r.h. 2000h

AVAILABLE AS

Terminated connector:
(E-2000™, F-3000™, DMI) simplex, and E-2000™ Backplane 2-6 channels

SPECIFICATIONS

CONNECTOR TYPE	WAVELENGTH (nm)	IL (dB) AGAINST REFERENCE		RL AGAINST REFERENCE		
		Typ.	Max.	Connected		Unmated
				PC 0°	APC 4°	APC 4°
E-2000™ PS	1625 - 1550 - 1310	0.2	0.4	45	75	50
	1060 - 980	0.3	0.6	35*	60*	
DMI PS	1625 - 1550 - 1310	0.2	0.4	45	75	50
	1060 - 980	0.3	0.6	35*	60*	
F-3000™ PS	1625 - 1550 - 1310	0.2	0.4	45	75	50
	1060 - 980	0.3	0.6	35*	60*	
TEST CONDITIONS		IEC 61300-3-4		IEC 61300-3-6 OLCR method / *OCWR method		

	VALUE	UNIT	TEST CONDITIONS
Mating durability	500	mate/demate cycles	IEC 61300-2-2
Fibre retention (fiber)	5	N	IEC 61300-2-4, 1min, longitudinal
Fibre torsion (fiber)	0.2	N	IEC 61300-2-5, ±180°, 25 cycles
Operating temperature	-40/+85**	°C	IEC 61300-2-22
Storage temperature	-40/+85**	°C	IEC 61300-2-17m -18

* Measured with high precision reflectometer ** May be further limited by cable specifications



DIAMOND SA • Via dei Patrizi 5 • CH-6616 Losone - Switzerland
Tel. +41 91 785 45 45 • Fax +41 91 785 45 00 • e-mail info@diamond-fo.com

www.diamond-fo.com

Specifications subject to change
without notice

BDD 1951541 07_17

CONNECTOR TYPES AND DIMENSIONS

E-2000™ PS connectors 900 μm - 3 mm boot style

Available types: **E-2000™ PS PC 0°**
E-2000™ PS APC 4°

Ferrule material: Zirconia/metal insert
 External parts PC 0°: Plastic (red body and thumb-latch; blue boot)
 External pasts APC 4°: Plastic (red body, thumb-latch and boot)

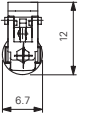
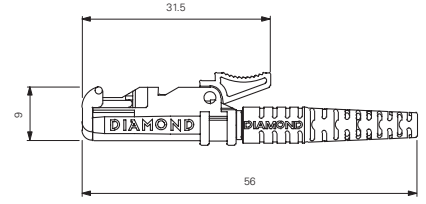

NOTE For color or mechanical keying thumb-latches, please refer to the E-2000™ standard datasheet

F-3000™ PS connectors 900 μm - 3 mm boot style

Available types: **F-3000™ PS PC 0°**
F-3000™ PS APC 4°

Ferrule material: Zirconia/metal insert
 External parts PC 0°: Plastic (red body and thumb-latch; blue boot)
 External pasts APC 4°: Plastic (red body, thumb-latch and boot)

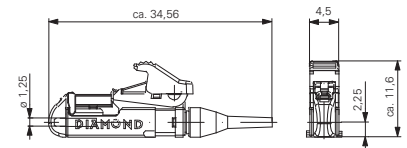
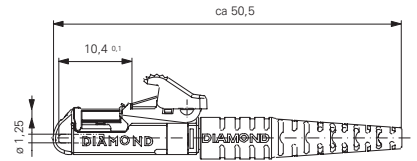

DMI PS connectors on 900 μm fiber, without boot

Available types: **DMI PS - PC 0°**
DMI PS - APC 4°

Ferrule material: Zirconia/metal insert
 External parts: Metal

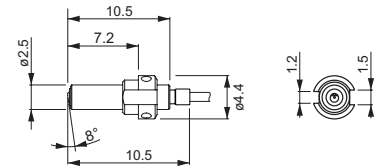
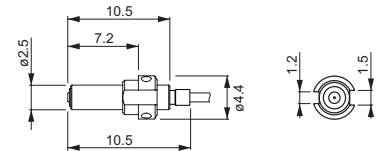

Mounting tool and instructions:

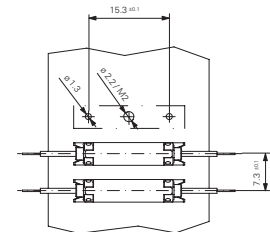
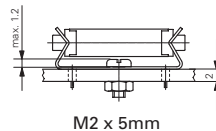
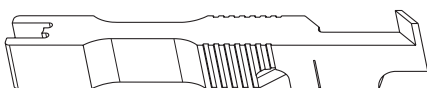

For further information about mounting instructions, please refer to the DMI Part number list

ORDER INFORMATION

Please refer to the part numbers provided in the separate P/N list.
 For assemblies or other configurations, please contact your nearest local Diamond representative or fill in the contact form available on the www.diamond-fo.com website.

ADAPTER TYPES AND DIMENSIONS

E-2000™ PS mating adapter

Available types: **E-2000™**
 External parts PC 0°: Plastic (red body and blue frames)
 External parts APC 4°: Plastic (red body and frames)
 Mating sleeve: Zirconia

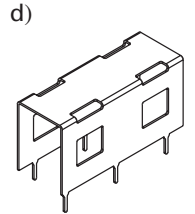
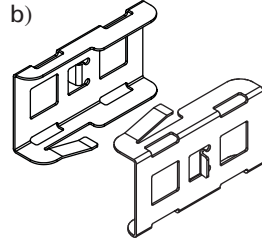
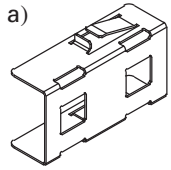
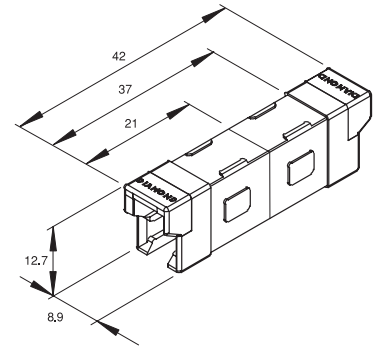

CUTOUT DIMENSIONS

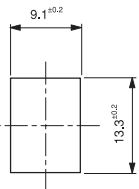

Max wall thickness 1.6 mm

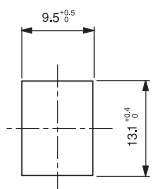

Max wall thickness 1.6 mm

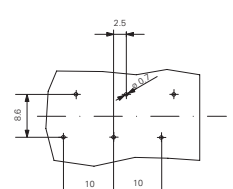
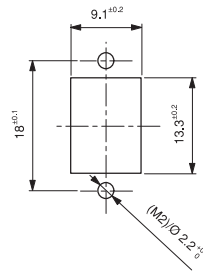

F-3000™ PS mating adapter

Material: Plastic red
 Mating sleeve: Zirconia

CUTOUT DIMENSIONS

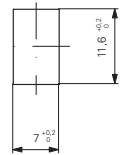
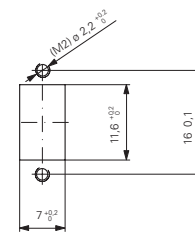
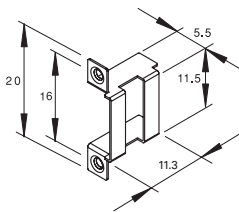
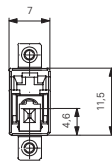
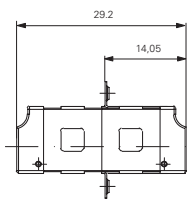

Max wall thickness 1.6 mm

DMI PS mating adapters

External parts: Metal
 Mating sleeve: Zirconia
 Cap colors: Red

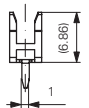
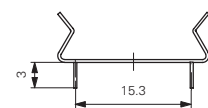
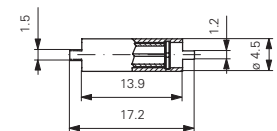

DMI mating adapters clip

External parts: Metal (Cu Be₂; tinned solderable)

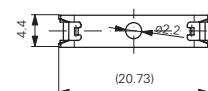

SAFETY INFORMATION FOR POWER SOLUTION CONNECTORS

The Power Solution (PS) connector utilizes expanded beam technology to reduce the density of the optical power at the interface of the connection. This insures that the connector is less sensitive to contamination and maximum power can be transmitted to the connector without damage.

CLEANING

Cleanliness is a high priority when dealing with high power applications. As such, the basic concept when using PS connectors is as follows:

- Before each mating procedure, the connectors must be absolutely clean and inspected with a microscope.
- The ferrule's surface inspection should be performed using an optical microscope with a magnification of at least 200x.
- The connector is normally affected by contamination during handling and mating procedures and the degree of cleanliness of the overall installation is also a critical parameter to be taken into consideration.

HANDLING

Power Solution connectors should be operated only when connected to high power. When unmated, the light source must absolutely be switched off.

SAFETY

Optical connectors are passive components not subjected to Laser safety, but will be when integrated in an active system, such as the output side of a light source.

The following aspects are taken into account when evaluating laser safety requirements:

- The exit beam of these connectors must have a lower Numerical Aperture (NA) as standard connectors in air ($NA=0.035$) or ca. 2° divergence. This is used in the calculation of the amount of light that can enter the pupil at 1m.
- The DMI connector does not have a protection cap, therefore, Diamond recommends to putting a protection cap on top with the indication of the laser class according to IEC 60825-1.

The following safety precautions are to be considered as a starting point and each individual is responsible to insure and demand proper safety protocols. The following precautions should not be considered as sufficient and should be re-evaluated from case-to-case.

- Use in a restricted area and allow access only to authorized and qualified personnel.
- Use protective glasses; skin protective measures are also recommended.
- Keep optical behaviour under control: eliminate reflections (also diffuse), close unused optical channels, and avoid light beams at eye level.
- Switch the system on/off with a remote control or interlock and utilize an additional automatic switch off safety system.
- Provide a warning signal when sources are active.
- Provide laser classification markings and danger indications.

Systems that rely upon a minimum required RL level, should use a non-contact PC version with possibly interlock capabilities.
