

# DIAMOND

## Fiber Optic Components

### FC Fusion

SINGLE MODE PC/APC  
MULTIMODE PC

#### CABLE ASSEMBLIES AND ADAPTERS

The FC FUSION allows you to quickly and easily make field terminations with the performance you expect from Diamond-quality FC connectors. The key to this system is DIAMOND's advanced "crocodile alberino" fusion field ferrule assembly. The ferrule assembly consists of a factory-terminated fiber endface, fiber stub, and integrated splice protection. The fiber endface is core-centered via Diamond's well-known Active Core Alignment process and factory-polished to the company's precise specifications. The FC FUSION is then field terminated via a low loss fusion splice using the new Diamond ZEUS D50 Fusion Field Termination Kit. The FC FUSION is available for SM and MM fiber (250µm, 600µm & 900µm) and cable (1.6-to 3.1 mm) in both 0° PC or 8° APC versions. Other fiber types can also be accommodated upon request.

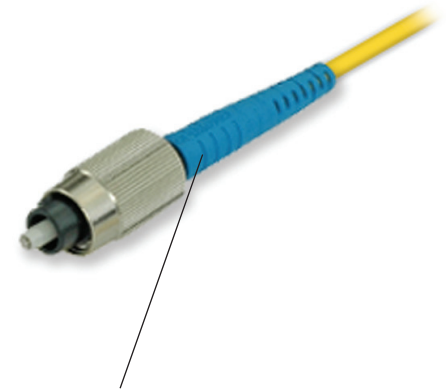

Crocodile Alberino 2.5mm

#### FEATURES AND BENEFITS

- ▶ Simple, fast and reliable field termination  
*reduces operator error and cost per termination*
- ▶ Outstanding optical performance  
*consistent and repeatable low IL / high RL*
- ▶ No polishing  
*eliminates the need for costly consumables*  
*operator independent performance*
- ▶ Fusion spliced pigtail performance and reliability without the cost and space associated with splice enclosures, trays and protectors.



Initial condition

#### AVAILABLE AS

- ▶ Connector set, (to be terminated with Diamond special equipment)



Closed before housing assembly

#### SPECIFICATIONS

	MULTIMODE 0° PC	SINGLE MODE 0° PC	SINGLE MODE 8° APC	UNITS	TEST CONDITIONS
Insertion Loss (IL)	typ. 0.2 max 0.5	typ. 0.25 max. 0.5	typ 0.25 max. 0.5	dB	IEC 61300-3-4; λ = 1300/1550nm
Return Loss (RL)	min. 40	min. 50	min. 70*	dB	IEC 61300-3-6; λ = 1300/1550nm
Repeatability of IL	max. ±0.1			dB	IEC 61300-2-2; λ = 1300/1550nm
Service life	1000 mate/demate cycles				According to field experience
Operating temperature	-25/+70**			°C	
Storage temperature	-25/+70**			°C	

\* Measured with high precision reflectometer  
\*\* May be further limited by cable specifications



DIAMOND SA | Via dei Patrizi 5 | CH-6616 Losone - Switzerland  
Tel. +41 58 307 45 45 | e-mail info@diamond-fo.com

[www.diamond-fo.com](http://www.diamond-fo.com)

Specifications subject to change  
without notice

BDD 1950271 08\_20

## CONNECTOR TYPES AND DIMENSIONS

FC Fusion connectors 900 μm - 3 mm boot style

Available types: **FC Fusion PC (Key Ø2.14 mm)**  
**FC Fusion APC (Key Ø2 mm)**  
**FC Fusion APC (Key Ø2.14 mm)**

Ferrule material: Zirconia/copper-nickel alloy insert  
 External parts: Ni-plated brass/Plastic

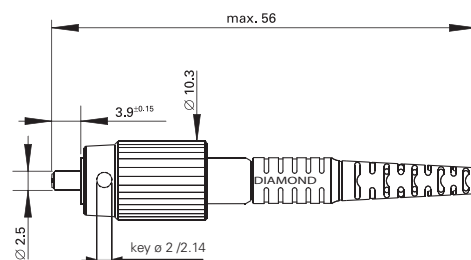

## ADAPTER TYPES AND DIMENSIONS

External parts: Ni-plated brass  
 Mating sleeve: Zirconia

FC mating adapter square flange

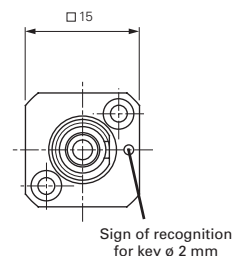
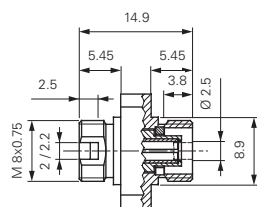

CUTOUT DIMENSIONS

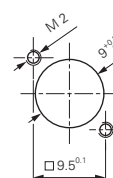

FC mating adapter hexagonal flange

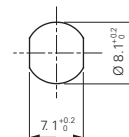
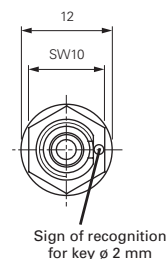
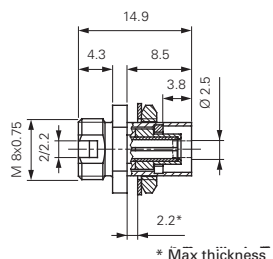

FC mating adapter round flange

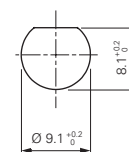
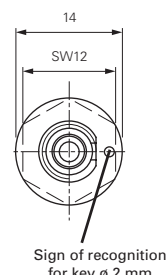
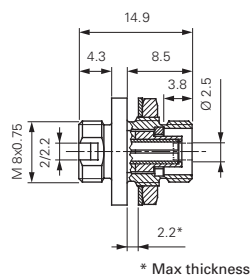

**NOTE** Diamond's standard **boot** colors are as follows: Black for MM PC 50μm, Beige for MM PC 62.5μm, Blue for SM PC, and Green for SM APC. Other colors are available upon request.

## ORDER INFORMATION

Please refer to the part numbers provided in the separate P/N list.

For other configurations, please contact your nearest local Diamond representative or fill in the contact form available on the [www.diamond-fo.com](http://www.diamond-fo.com) website.

## FC FUSION INSTALLATION CONCEPT

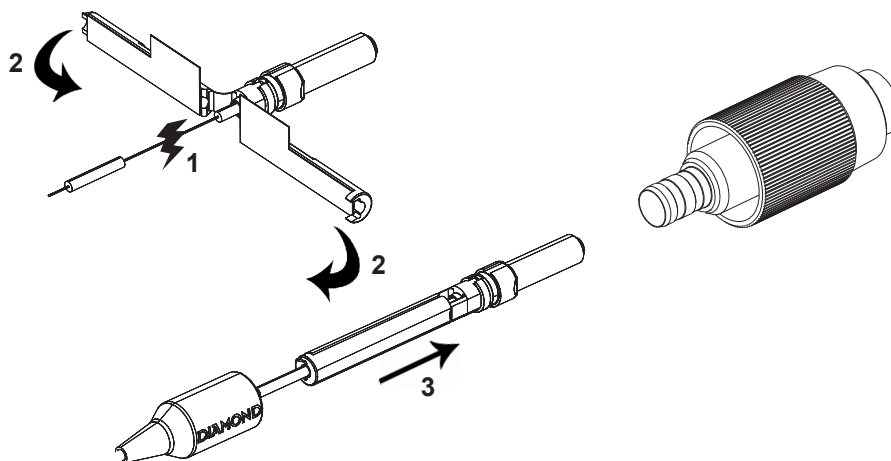

## TERMINATION KIT

DIAMOND's new ZEUS D50 Fusion Field Termination Kit provides all the tools and instructions necessary for high performance field terminations of DIAMOND's Fusion E-2000®, F-3000®, SC, FC and ST™ connectors.

## ORDER INFORMATION

Please refer to the part-specific ZEUS D50 Fusion Field Termination Kit datasheet.



## BASE KIT

- |   |   |
|---|---|
| <ol style="list-style-type: none"> <li>1. ZEUS D50 fusion splicer</li> <li>2. Fiber cleaver</li> <li>3. Stripping pliers</li> <li>- Soft bag</li> </ol> | <ol style="list-style-type: none"> <li>4. Holder left and right</li> <li>5. Connector assembling tools</li> <li>6. Holder for Alberino Crocodile</li> </ol> |
|---|---|